

Cable Tie Accessories 扎带附件

TieMounts 定位片

Description

Available in either screw or self adhesive mounting this range offers a safe and secure fixing base.

Simple to install with a screw or bolt they give excellent security, particularly in areas of high vibration.

The Self Adhesive mounts are designed to offer the maximum surface area, and in conjunction with the specially developed adhesive ensures that a very high pull-off force is achieved.

Material: UL94V-2 approved PA 6.6

Application

Designed specifically for holding heavier cable bundles these mounting bases can be used in many industries from agriculture to truck manufacture. They offer a very secure fixing and can be used with a wide variety of heavy duty cable ties up to 8mm wide.

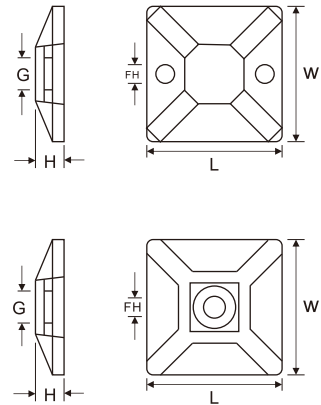
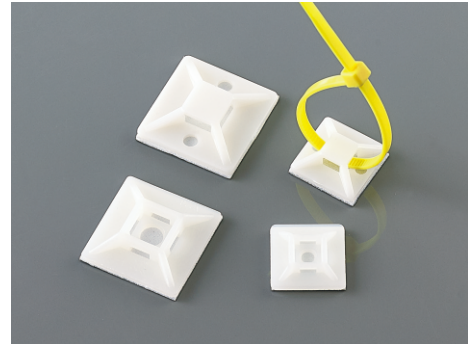
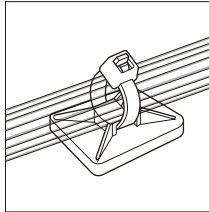

'4-Way' Enter Available Size



Part No. 货号	Item Code 型号	Length (L) 长度	Width (W) 宽度	Height (H) 高度	Fixing Hole (FH) 孔径	Strap Width Max.(G) 最大扎带宽度
		mm	mm	mm	Ø(mm)	mm
6400	TM-20	20	20	6.1	2.9	5.0
6402	TM-25	25	25	7.5	3.5	6.2
6404	TM-30	30	30	8.7	4.5	6.4
6406	TM-35	40	40	6.4	/	10.8

'2-Way' Enter Available Size

Part No. 货号	Item Code 型号	Length (L) 长度	Width (W) 宽度	Height (H) 高度	Fixing Hole (FH) 孔径	Strap Width Max.(G) 最大扎带宽度
		mm	mm	mm	Ø(mm)	mm
6408	MB-1	19	19	4.6	/	4.4
6410	MB-2	28	28	6.4	5.5	5.4

Screw Tie Mounts 扎带固定座

Description

Simple to install with a screw or bolt they give excellent security.

Material: UL94V-2 approved PA 6.6

Available Size



Part No. 货号	Item Code 型号	Length (L) 长度	Width (W) 宽度	Height (H) 高度	Fixing Hole (FH) 孔径	Strap Width Max.(G) 最大扎带宽度
		mm	mm	mm	Ø(mm)	mm
6420	STM-1S	13	7	5.8	3.3	3.8
6422	STM-1	15	10	7	3.4	5.0
6424	STM-1L	22	15	9	6	5.8
6426	STM-2	28.8	15	11.8	5.2	9.3

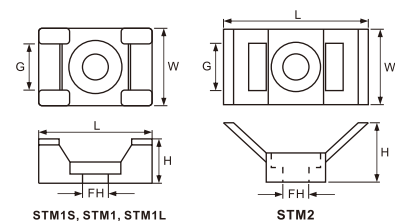

Cable Tie Accessories 扎带附件

Anchor Tie Mount 扎带固定座

Description

The Mounts are suitable for applications with minimal space. They are mounted onto the equipment prior to cable installation as they are installed 'in line' and take up no more space than the cable itself. They have a '4-way' enter design and can be used either 'in line' or at 90° to the cable run.

Material: PA 66

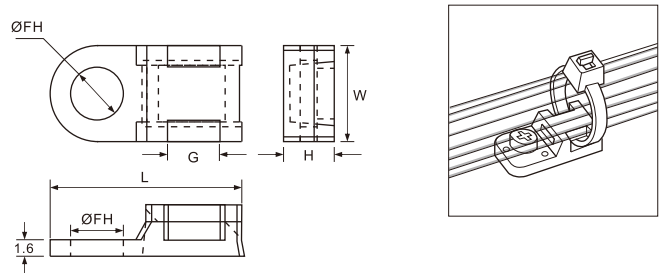

Available Size



Part No. 货号	Item Code 型号	Length (L) 长度	Width (W) 宽度	Height (H) 高度	Fixing Hole (FH) 孔径	Strap Width Max.(G) 最大扎带宽度
		mm	mm	mm	Ø(mm)	mm
6430	ATM-1	19	9.4	5	4.4	4.6

Push Tie Mount 插销式扎带固定座

Description

The push mount tie mount is ideal for applications with restricted access, or where space-saving is required. The arrowhead simply pushes into a pre-drilled or pre-punched hole give a very secure fixing.

Material: PA 66
 Color: Natural

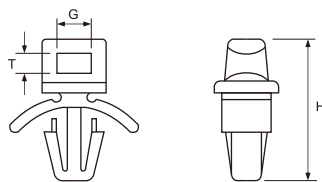
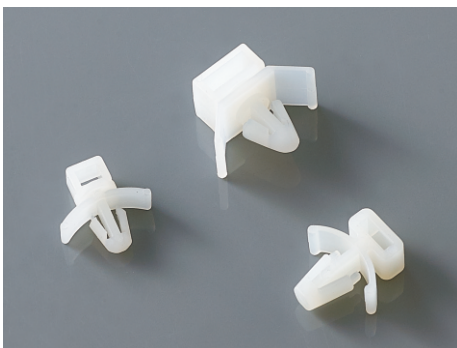

Available Size



Part No. 货号	Item Code 型号	Fixing Hole Diameter 基板孔径	Height (H) 高度	Strap Thickness 最大扎带厚度 Max.(T)	Strap Width 最大扎带宽度 Max.(G)
		mm	mm	mm	mm
6440	PTM-4	4.8	15.5	1.6	3.7
6442	PTM-6	5.5	17.2	1.7	6.2
6444	PTM-8	6.2	18.5	2.8	8.3



Cable Tie Accessories 扎带附件

Cable Tie Holder 扎带固定座

Description

The cable tie holder are available in 2 sizes for 3/8" and 3/10" diameter holes. Parts are molded in natural or black U.V. Stabilized PA 6.6, and are suitable for use in pre-drilled holes in wood, masonry, and a variety of other materials.

Material: PA 66
 Color: White & Black

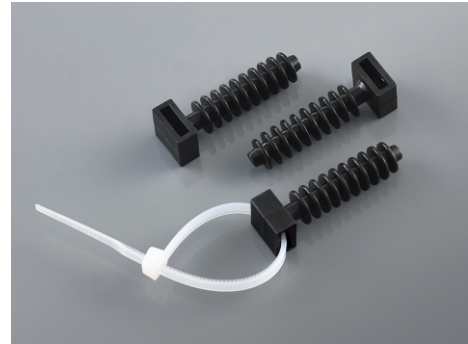
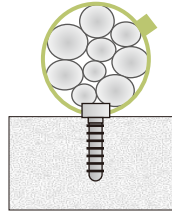

Available Size

Part No. 货号	Item Code 型号	Head Width 头宽 L mm	Strap Width Max. 最大扎带宽度 L1 mm	Screw Length 螺纹长度 H mm	Head Height 头高 H1 mm	Screw 螺纹直径 D Ø(mm)
6450	CTH-1	12.7	9.7	37	6.0	10
6452	CTH-2	12.7	9.7	31	6.0	8

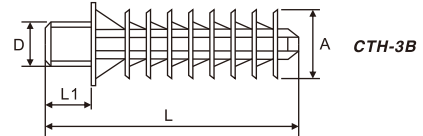
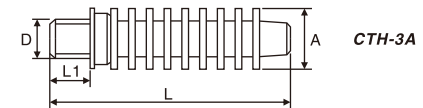
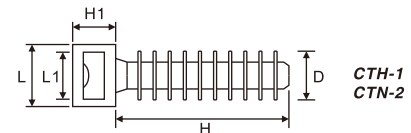

Available Size

Part No. 货号	Item Code 型号	Length 长度 L mm	Head Length 头高 L1 mm	Head 头直径 ØD mm	Screw 螺纹直径 ØA mm
6454	CTH-3A	38	6	M7x1.5	10
6456	CTH-3B	39	7	M6x1.5	10

Cable Tie Hook 扎带固定挂钩

Description

Cable tie hook is a flat strap plastic hook with a cable tie through hole. It can be used with max. 5mm width cable ties which can attached the hook on the panel and has an open hook that can be used to hang things. The hooks are durability and excellent load bearing capacity.

Material: PA 66
 Color: Black

Part No.: 6458

